

# *Operation Manual*

## *Pediatric Audiometer PA5*



**Valid from serial 01**  
80691202 – 07/2008



# Table of Contents

<b>Table of Contents</b> .....	<b>1</b>
<b>Introduction</b> .....	<b>2</b>
Intended Use .....	2
Precautions.....	2
<b>Basic Functions</b> .....	<b>4</b>
Description of Control Panel.....	4
Description of Stimuli Panel .....	5
<b>Batteries</b> .....	<b>6</b>
Replacing Batteries .....	6
Approximate Battery Lifetime .....	6
<b>Auditory Behaviour</b> .....	<b>7</b>
Auditory Behaviour -Test Overview.....	7
Description of Various Tests .....	8
Auditory Behaviour Index for Infants .....	9
Reflex Audiometry by Neonates.....	10
Maturation of Auditory Response.....	10
<b>Technical Specifications</b> .....	<b>13</b>
<b>Unpacking / Inspection</b> .....	<b>15</b>
Contents of Shipment.....	15
Reporting Imperfections .....	16
<b>Trouble Shooting</b> .....	<b>17</b>
<b>Recommended Literature</b> .....	<b>18</b>
<b>Appendix: General Maintenance Procedures</b> .....	<b>19</b>
<b>Return Report</b> .....	<b>21</b>

## Introduction

### Intended Use

The PA5 handheld paediatric screening audiometer is designed to be a device for screening for hearing loss primarily amongst children. Output and specificity of this type of device are based on the test characteristics defined by the user, and may vary depending on environmental and operating conditions. The screening for hearing loss using this kind of audiometer depends on the interaction with the patient. However, for children not responding well, various test possibilities allow the tester of having at least some evaluative result. Thus, a “normal hearing” result should not allow for ignoring other contra indications in this case. A full audiologic evaluation should be administered if concerns about hearing sensitivity persist.

### Precautions

**Notice** - Be sure to use only stimulation intensities, which will be acceptable for the patient.

**Notice** - The transducers (headphones, bone conductor, etc.) supplied with the instrument are calibrated to this instrument - exchange of transducers require a recalibration.

**Notice** - It is recommended that parts which are in direct contact with the patient (e.g. earphone cushions) are subjected to standard disinfecting procedure between patients. This includes physically cleaning and use of a recognised disinfectant. Individual manufacturer's instruction should be followed for use of this disinfecting agent to provide an appropriated level of cleanliness.

**Notice** - Always remove the batteries when the instrument is left unused for more than a month.

**Notice** - Although the instrument fulfils the relevant EMC requirements precautions should be taken to avoid unnecessary exposure to electromagnetic fields, e.g. from mobile phones etc. If the device is used adjacent to other equipment it must be observed that no mutual disturbance appears.

**Notice** - Within the European Union it is illegal to dispose electric and electronic waste as unsorted municipal waste. Electric and electronic waste may contain hazardous substances and therefore has to be collected separately. Such products will be marked with the crossed-out wheeled bin shown below. The cooperation of the user is important in order to ensure a high level of reuse and recycling of electric and electronic waste. Failing to recycle such waste products in an appropriate way may endanger the environment and consequently the health of human beings.

Disposal of batteries must be made according to national regulations.



# Basic Functions

## Description of Control Panel

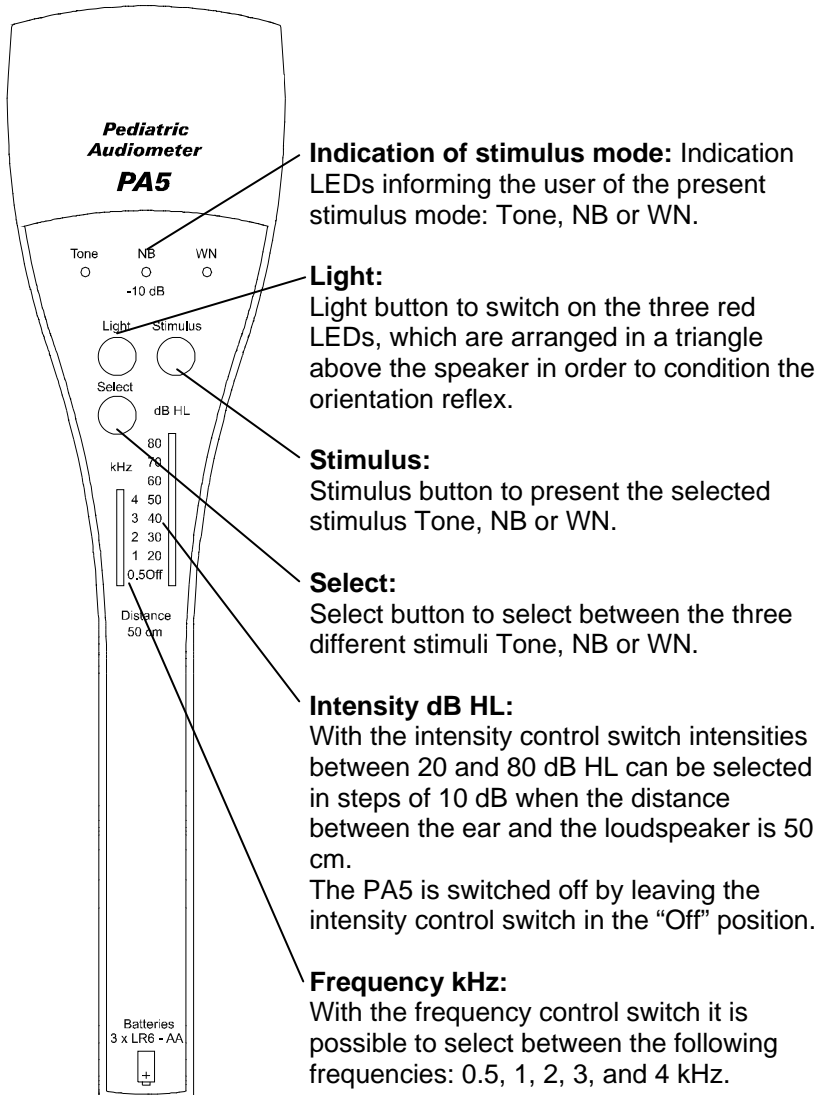

## Description of Stimuli Panel

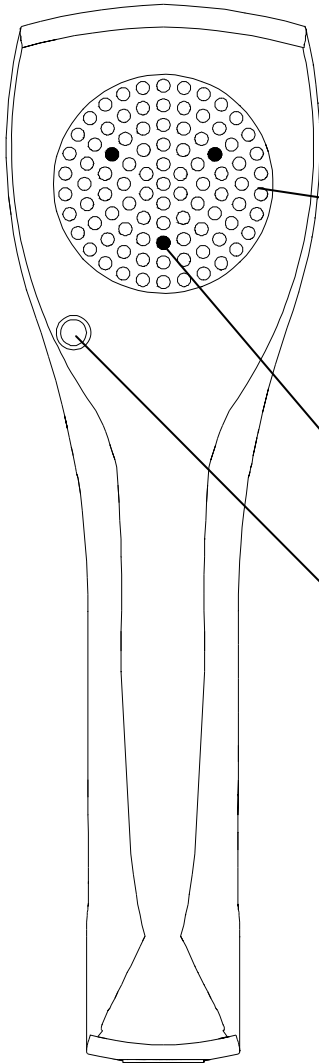

**Loudspeaker:**

The loudspeaker is to be found underneath the black grid. When used the grid should be positioned in a distance of 50 cm (20 inches) from the ear in order to obtain the intensities printed on the Control Panel.

**LEDs:**

Three LEDs arranged in a triangle for conditioning of the orientation reflex.

**Headphone Connector:**

Connector for single Headphone TDH39S (optional). When the headphone is connected PA5 will automatically go to Pure Tone stimulation and correct calibration for Pure Tone Audiometry with TDH39S will be applied.

The connector is a 3.5 mm stereo Jack.  
Pin assignment:

Tip = Not used  
Ring = Signal  
Sleeve = Signal

# Batteries

## Replacing Batteries

To replace old batteries unscrew the small black lid in the narrow end of PA5 and the batteries can be removed. Replace with three new AA batteries. When inserting the new batteries please make sure that they are inserted correctly according to the small drawing in the bottom part of the control panel.

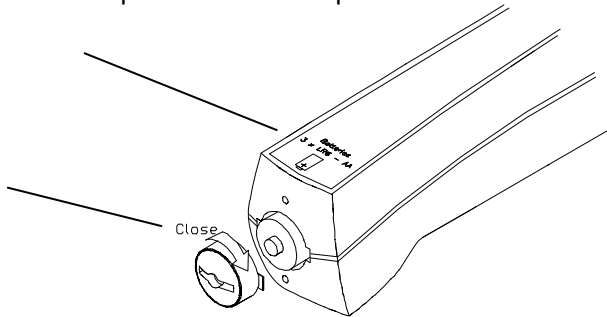

PA5 contains 3 batteries, size LR6, AA or Mignon. Alkaline or rechargeable (NiMH or NiCa).

## Approximate Battery Lifetime

The battery lifetime using alkaline battery type:

With the instrument switched off:	12 months
With 80 dB tone switched on:	10 hours
With 80 dB tone and light switched on:	4 hours

### Battery Level indication:

When the batteries need to be replaced the LED indication for the present used stimulus will gradually reduce in light intensity and finally switch off.

**Note:** Always remove the batteries when the instrument is left unused for more than a month.



# Auditory Behaviour

## Auditory Behaviour -Test Overview

	Waking up	Respiration Aud.	APR	COR	VRA
Recommended age group (month)	0 - 3	0 - 4	0 - 12	4 - 15	6 - 30
Preferred Frequency:					
500 Hz				x	x
1000 Hz				x	x
2000 Hz		x	x	x	x
3000 Hz	x	x	x	x	x
4000 Hz	x	x	x	x	x
Tone Duration (Sec)	1.5-2	1-2	0.5-1	0.5-1	0.5-1
Time between Stimulation (sec)	30	20	10-20	10-20	10
MRL <sup>1</sup> (sound cabin) (dBHL)	40-80	40-80	40-80	30-60	20-40
Distance to test ear (cm)	10-50	10-50	10-50	50-100	50-100
Condition of child:					
- sleeping	x	x			
- half asleep	x	x	x		
- awake		x	x	x	
- playing				(x)	(x)
- playing alert				x	x
Recom. no. of PA5s for the test:	1	1	1	2	2

<sup>1</sup> MRL: Minimum Response Level (Matkin 1977).

## Description of Various Tests

As found by Professor Sanford E. Gerber complex signals like White Noise (WN) assure better responsiveness on neonates and up to the age of approximately seven months than e.g. pure tones and Narrow Band Noise. Therefore PA5 has the possibility of stimulating with WN.

### **The APR Test:**

The Auropalpebral Reflex is a startle reflex of the eyelid elicited by relatively strong sounds, approximately 80 - 100 dB SPL (PA5 is calibrated in dB HL).

The test can be performed on neonates from the day of birth and it is not based on co-operation with the newborn child. Other responses than the APR can be arousal from sleep, crying or diminished activity.

### **The COR Test:**

The Paediatric Audiometer PA5 can perform Conditioned Orientation Audiometry based on a technique described by Suzuki and Ogiba (1961). The phenomenon called "Orientation Reflex" is not a learned response, but a natural reflex movement elicited by sound or visual stimulation.

If the visual stimulation elicits a reflex which is conditioned by a tone, the child will look towards the visual stimulation, e.g. flashing light, as soon as the tone is heard. If the conditioning is effective the child will look in the direction of the sound source even before the visual stimulation is presented. The COR method requires cooperation from the child.

### **The VRA Test:**

The Paediatric Audiometer PA5 can perform the Visual Reinforcement Audiometry (Liden and Kankunen, 1969), which is an extension and modification of COR, where the co-operation with the child is less important. Liden and Kankunen accept not only the sound localisation orientation reflex, but also four other reactions: reflex reactions (body and face), search reactions, orientation reactions and spontaneous reactions.

## Auditory Behaviour Index for Infants

Age	Reaction on noisemaker (approx. dB SPL)	Reaction on warbled pure tones (dB HL)	Reaction on Speech (dB HL)	Expected Response
<b>0–6 weeks</b>	50-70 dB	78 dB (± 6)	40-60 dB	Eye-widening, eye-blink, stirring or arousal from sleep, startle.
<b>6-16 weeks</b>	50-60 dB	70 dB (± 10)	40 dB (± 2)	Eye-widening, eye-shift, eye blink, quieting: beginning rudimentary head turn by four month.
<b>4-7 months</b>	40-50 dB	51 dB (± 9)	21 dB (± 8)	Head turn on lateral plane towards sound: listening attitude.
<b>7-9 months</b>	30-40 dB	45 dB (± 15)	15 dB (± 7)	Direct localisation of sounds to side, indirectly below ear level.
<b>9-13 months</b>	25-30 dB	38 dB (± 8)	8 dB (± 7)	Direct localisation of sounds to side, directly below ear level indirectly above ear level
<b>13-16 months</b>	25-30 dB	32 dB (± 10)	5 dB (± 5)	Direct localisation of sounds.
<b>16-21 months</b>	25 dB	25 dB (± 10)	5 dB (± 1)	Same.
<b>21-24 months</b>	25 dB	26 dB (± 10)	5 dB (± 2)	Same.

Stimulus as PA5

(From Northern and Downs: Hearing in Children) Copyright © 1974 the Williams and Wilkins company. By permission of publisher and author).

## Reflex Audiometry by Neonates

The reflex pattern elicited by sound can be divided into the following types of reflexes (Relke and Frey 1966). The sound intensity is 75 – 90dB.

### **Breathing Reflex**

The breathing rhythm is changing when the sound is heard and should stabilise after 5-10 seconds.

### **Auopalpebral Reflex (APR)**

The open eyelids will be closed fast and clear.

### **Moving Reflex**

The neonatal child will move heavily after a quiet period.

### **Crying Reflex (Scream)**

The face of the child will indicate discomfort and shortly after followed by weeping or a scream.

### **Astonishment Reflex**

Crying and body movements stop momentarily as if the child is asking: "What is going on"?

### **Waking up Reflex**

The breathing rate is accelerating; the child starts moving, wakes up and opens the eyes.

## Maturation of Auditory Response

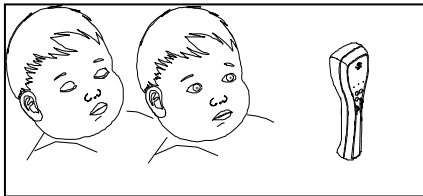

### Newborn to 2 months of age

Arousal from sleep. MRL<sup>2</sup> in quiet surroundings 50-70 dB.  
MRL in noisy surroundings: 90

<sup>2</sup> Minimum response level, dB HL. The MRL levels are recorded in sound cabins. In noisy surroundings the levels will have to be correspondingly higher.

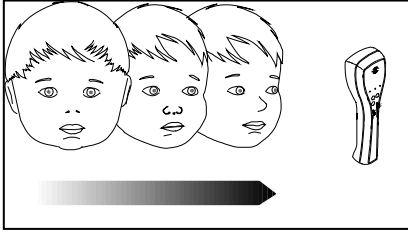

3-4 months of age

Rudimentary head turn, horizontally.

MRL: 50-60 dB.

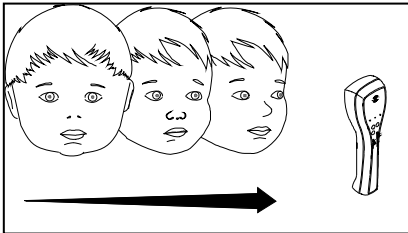

4-7 months of age

Sound localisation to the side only, not above or below eye level.

MRL: 40-50 dB.

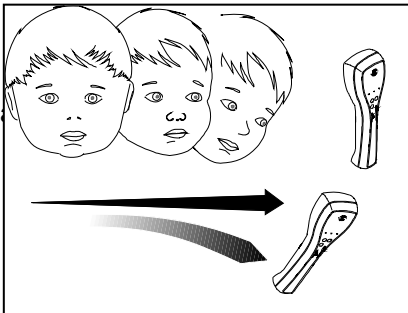

7-9 months of age

Sound localisation to the side Indirect below. (Not above).

MRL: 30-40 dB.

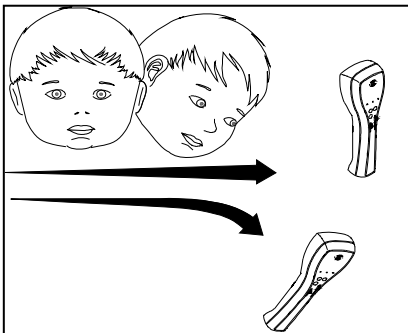

9-13 months of age

Sound localisation to the side and direct below.

MRL: 25-35 dB.

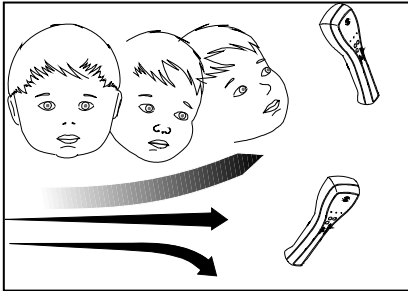

13-16 months of age

Sound localisation to the side, below and indirect above.

MRL: 25-35 dB.

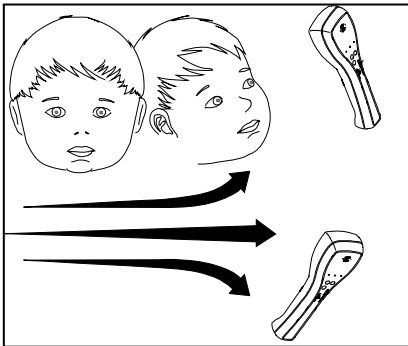

16-21 months of age

Direct sound localisation to the side, below, indirect above.

MRL: 25-35 dB.

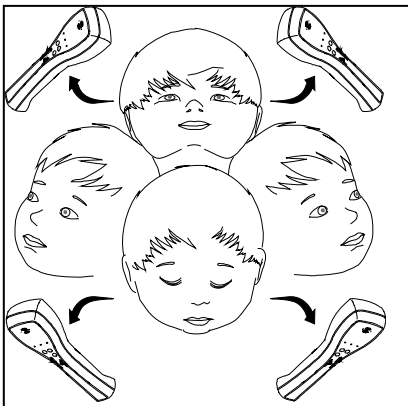

21-24 months of age

Locates directly sound at any angle.

MRL: 25-30 dB.

(Above illustrations and explanations are inspired by Northern, J.L., Downs, M.P.: Hearing in Children. 2. ed. William A. Wilkins, Baltimore, 1978).

# Technical Specifications

## Standards:

Audiometer: EN 60645-1, Type 5  
Sound Pressure Level of the loudspeaker: ISO 389-7  
Sound Pressure Level of the headphone: ISO 389-1  
EMC: EN 60601-1-2

## Medical CE-Mark:



The CE-mark indicates that Interacoustics A/S meets the requirements of Annex II of the Medical Device Directive 93/42/EEC. TÜV Product Service, Identification No. 0123, has approved the quality system.

## Power:

Batteries: 3 x AA, LR6 or Mignon.  
Alkaline or rechargeable (NiMH or NiCa).

## Frequencies:

500, 1000, 2000, 3000, 4000 Hz.

## Stimuli:

Warble Tone, NB, and WN.

## Intensities:

Distance 50 cm: 30 – 80 dB HL in 10 dB steps for Warble Tone and WN.  
20 – 70 dB for NB  
Distance 16 cm Increases the indicated intensity by 10 dB.

## Warble Frequency:

5 Hz,  $\pm$  5%.

## Stimulation using TDH39S:

Pure Tone: 500, 1000, 2000, 3000 and 4000 Hz.  
Intensities of 30 – 80 dB (independent calibration applied when TDH39S is connected).

## Sound Source:

Built-in loudspeaker or audiometric headphone TDH39S  
(independent calibration registers).

**Light Stimulation:**

3 LED's arranged in a triangle, flash speed 5 Hz (5 pulses per sec).

**Tone and Light Stimulation:**

Silent presentation switch.

**Approximate Battery Lifetime:**

The battery lifetime using alkaline battery type:

With the instrument switched off: 12 months

With 80 dB tone switched on: 10 hours

With 80 dB tone and light switched on: 4 hours

**Dimensions:**

L x W x H: 25 x 7 x 5 cm / 9.8 x 2.7 x 2 inches.

Weight: 0,36 kg incl. batteries.

0,8 lb. incl. batteries.

**Warm-up time:**

The PA5 is ready for instant use and does not require any warm-up time.

**Environmental conditions:**

The specification for the instrument is valid if the instrument is operated within the following environmental limits:

Temperature: 15°C to 35 °C.

Humidity: 30 %RH to 90 %RH

Transportation and storage of the instrument should be within the following environmental conditions:

Temperature: Transportation: -20° to 50°

Storage: 0° to 50°

Humidity: 10%RH to 95% RH

Non-condensing. Keep dry.



## Unpacking / Inspection

### **Check box and contents for damage:**

When the instrument has been received, please check the shipping box for rough handling and damage. If the box is damaged, it should be kept, until the contents of the shipment have been checked mechanically and electrically. If the instrument is faulty, please contact the nearest service office. Keep the shipping material for the carrier's inspection and insurance claim.

### **Keep carton for future shipment:**

The PA5 comes in its own shipping carton, which is specially designed for the PA5. Please keep this carton. It will be needed if the instrument has to be returned for service. If service is required, please contact your nearest sales and service office.

## Contents of Shipment

### **Delivered items with PA5:**

PA5 delivered as standard contains the following:

- PA5 Paediatric Free Field Audiometer
- 3 AA Batteries
- PA5 Handbag
- Operation Manual
- Service Manual
- Multilingual Instruction for Use

### **Check numbers on PA5 and Manual:**

The identification label on the rear plate holds the serial number. This should be checked with the manual number, and written down for later service claims.

## Reporting Imperfections

### **Report immediately any faults:**

The cabinet and the accessories should be checked visually for scratches and missing parts.

Any missing part or malfunction should be reported immediately to the supplier of the instrument together with the invoice, serial number and a detailed report of the problem. In the back of this manual you will find a "Return Report", where you can describe the problem.

### **Please use "Return Report":**

Please realise that if the service engineer does not know what problem to look for he may not find it, so using the Return Record will be of great help to us and is your best guarantee that the correction of the problem will be to your satisfaction.

### **Annual calibration headset:**

The PA5 has been designed to provide many years of reliable service, but annual calibration is recommended due to possible impact on transducers.

We do also recommend to calibrate the PA5, if something drastic happens to the instrument (e.g. if the instrument was dropped on the floor).

## Trouble Shooting

**PA5 does not turn on:**

The batteries have to be replaced.

The batteries might be wrongly inserted into the instrument (see passage concerning “Batteries” on page 6 of this manual).

**No stimuli from the PA5s internal loudspeaker:**

The “dB HL” intensity control is switched off.

**No tones in the TDH39 headphone:**

The “Tone” presentation signal (10) must be activated by touching the Tone Switch.

If no sound appears check that the headphone is correctly connected to the “Headphone Connector” on the stimuli panel output and that the jack is fully inserted.

## Recommended Literature

**Jerger, James:**

Paediatric Audiology, Current Trends

**Katz, Jack:**

Handbook of Clinical Audiology, Fourth Edition (Williams & Wilkins).

**Löwe, Armin:**

Pädagogische Hilfen für hörgeschädigte Kinder in Regelschulen.

**Löwe, Armin:**

Kinder-Audiometrie (Carl Marhold Verlagsbuchhandlung).

**McCormick, Barry:**

Paediatric Audiology 0 – 5 years, Second Edition (Taylor & Francis)

**Northern, Jerry L. and Downs, Marion P.:**

Hearing in Children (Williams & Wilkins).

## **Appendix:**

# **General Maintenance Procedures**

The performance and safety of the instrument will be kept if the following recommendations for care and maintenance are observed:

- It is recommended to let the instrument go through at least one annual overhaul, to ensure that the acoustical, electrical and mechanical properties are correct. This should be made by an authorised workshop in order to guaranty proper service and repair.
- Do not site the instrument next to a heat source of any kind, and allow sufficient space around the instrument to ensure proper ventilation.
- To ensure that the reliability of the instrument is kept, it is recommended that the operator at short intervals, for instance once a day, perform a test on a person with known data. This person could be the operator him/herself.
- If the surface of the instrument or parts of it are contaminated, it can be cleaned using a soft cloth moistened with a mild solution of water and dish washing cleaner or similar. The use of organic solvents and aromatic oils must be avoided. Always be careful that no fluid is entering the inside of the instrument or the accessories.
- After each examination of a patient, it should be ensured that there is no contamination on the parts in connection with the patient. General precautions must be observed in order to avoid that disease from one patient is conducted to others. If ear cushions or eartips are contaminated, it is strongly recommended to remove them from the transducer before they are cleaned. By frequent cleaning water should be used, but by severe contamination it may be necessary to use a disinfectant. The use of organic solvents and aromatic oils must be avoided.
- Great care should be exercised by the handling of earphones and other transducers, as mechanical shock may cause change of calibration.



# Return Report – Form 001



Opr. dato: 2003-02-24 af: EC Rev. dato: 2006-11-13 af: HNI Rev. nr.: 4

Company: \_\_\_\_\_

Address: \_\_\_\_\_  
\_\_\_\_\_

Phone: \_\_\_\_\_

Fax or e-mail: \_\_\_\_\_

Contact person: \_\_\_\_\_ Date : \_\_\_\_\_

**Address**  
Drejervaenget 8  
5610 Assens  
Denmark

**Phone**  
(+45) 63713555

**Fax**  
(+45) 63713522

**E-mail**  
info@interacoustics.com

## Following item is reported to be:

- returned to INTERACOUSTICS for:  repair,  exchange,  other: \_\_\_\_\_
- defective as described below with request of assistance
- repaired locally as described below
- showing general problems as described below

Item: \_\_\_\_\_ Type: \_\_\_\_\_ Quantity: \_\_\_\_\_

Serial No.: \_\_\_\_\_ Supplied by: \_\_\_\_\_

Included parts: \_\_\_\_\_

**Important! - Accessories used together with the item must be included if returned (e.g. external power supply, headsets, transducers and couplers).**

## Description of problem or the performed local repair:

\_\_\_\_\_  
\_\_\_\_\_  
\_\_\_\_\_  
\_\_\_\_\_

Returned according to agreement with:  Interacoustics,  Other : \_\_\_\_\_

Date : \_\_\_\_\_ Person : \_\_\_\_\_

Please provide e-mail address or fax No. to whom Interacoustics may confirm reception of the returned goods: \_\_\_\_\_

The above mentioned item is reported to be dangerous to patient or user <sup>1</sup>

In order to ensure instant and effective treatment of returned goods, it is important that this form is filled in and placed together with the item.

Please note that the goods must be carefully packed, preferably in original packing, in order to avoid damage during transport. (Packing material may be ordered from Interacoustics)

<sup>1</sup> EC Medical Device Directive rules require immediate report to be sent, if the device by malfunction deterioration of performance or characteristics and/or by inadequacy in labelling or instructions for use, has caused or could have caused death or serious deterioration of health to patient or user.