

Operation Manual

Screening Audiometer AS608/AS608e



**Valid from serial 744081
80696203 – ver. 06/2009**

Table of Contents

Table of Contents	1
Introduction	1
Intended Use	1
Extended Function	1
Precautions	2
Warranty	5
Air Conduction	7
Functions of Buttons & Display	10
Power Up and Power Off:	10
Pure Tone Presentation	10
AS608e Special Functions:	11
Display:	12
Setup Menu of AS608/AS608e	14
Technical Specifications	19
Parts	22
Electrical Installation	22
External Connections - Standard Accessories	24
Unpacking / Inspection	25
Contents of Shipment	25
Reporting Imperfections	26
Operating Temperature	27
Care and Maintenance	27
Trouble Shooting	28
Dictionary	29
Appendix: General Maintenance Procedures	30
Drawing of Front Plate	33
Return Report	35

Introduction

Intended Use

The AS608/AS608e screening audiometer is designed to be a device for screening for hearing loss. Output and specificity of this type of device are based on the test characteristics defined by the user, and may vary depending on environmental and operating conditions. The screening for hearing loss using this kind of audiometer depends on the interaction with the patient. “Normal hearing” result should not allow for ignoring other contra indications. A full audiologic evaluation should be administered if concerns about hearing sensitivity persist



The AS608/AS608e audiometer is intended to be used by an audiologist, hearing healthcare professionals, or trained technicians in a quiet environment. It is recommended that the instrument be operated within an ambient temperature range of 15-35 degree Celsius (59-95 degrees Fahrenheit)

Extended Function

The AS608e extends the AS608 functionalities with the following three extra features:

- PC Integration through the Diagnostic Suite software. This enables audiograms to be transferred and displayed in the Windows software and stored in the OtoAccess™ or Noah databases. The Diagnostic Suite also includes advanced reporting and printing features (similar to the AC440 software module.) Please refer to the Diagnostic Suite user manual for instructions about how to use the PC software suite.
- In addition to traditional manual testing, the AS608e incorporates a Hughson Westlake patient controlled automatic threshold test complying with ISO 8253. When the test is completed the results are easily recalled from the internal memory of the AS608.
- Talk Forward function that makes the AS608e easy to work with particularly in sound booth installations.

Precautions

	WARNING indicates a hazardous situation which, if not avoided, could result in death or serious injury.
	CAUTION , used with the safety alert symbol, indicates a hazardous situation which, if not avoided, could result in minor or moderate injury.
	NOTICE is used to address practices not related to personal injury.

NOTICE

Be sure to use only stimulation intensities, which will be acceptable for the patient.

NOTICE

The transducers supplied with the instrument are calibrated to this instrument - exchange of transducers require a recalibration.

NOTICE

It is recommended that parts which are in direct contact with the patient (e.g. earphone cushions) are subjected to standard disinfecting procedure between patients. This includes physically cleaning and use of a recognised disinfectant. Individual manufacturer's instruction should be followed for use of this disinfecting agent to provide an appropriated level of cleanliness.

NOTICE

Never insert or in any way use the insert headset without a new clean non defect test tip.



External equipment intended for connection to signal input, signal output or other connector, shall comply with relevant IEC standard (e.g. IEC 60950 for IT equipment and the IEC 60601 series for medical electrical equipment). In addition, all such combinations – *systems* – shall comply with the standard 60601-1-1, *Safety requirements for medical electrical systems*. Equipment not complying with IEC 60601 shall be kept outside patient environment, as defined in standard (at least 1.5 m from the patient).

Any person who connects external equipment to signal input, signal output or other connectors has formed a system and is therefore responsible for the system to comply with the requirements of IEC 60601-1-1. If in doubt, contact your service technician or local representative for help.

If connection is made to a standard PC which is powered through the mains network, special precautions must be taken in order to maintain medical safety.

A standard USB cable can *only* be used, if the connected PC is:

- running on battery, or
- medical approved, or
- powered via a medical approved safety transformer.

In all other cases, a galvanic separator must be inserted in the USB connection.

NOTICE

The AS608/AS608e is intended to be powered from a PC as described above, from batteries or from a medical power supply type ASA30M-0301. Using other supplies is not allowed.

NOTICE

Do not site the AS608/AS608e next to a radiator or any other heat source. Allow six inches between the back panel and the wall to ensure proper ventilation.

NOTICE

In operation the instrument should not be subject to temperatures below 15C° or above 35C°. If the instrument is moved from

a cold location to a warmer one, there will be a risk of condensation. If condensation occurs the instrument must be allowed to achieve normal temperature before it is turned on.

NOTICE

Although the instrument fulfils the relevant EMC requirements precautions should be taken to avoid unnecessary exposure to electromagnetic fields, e.g. from mobile phones etc. If the device is used adjacent to other equipment it must be observed that no mutual disturbance appears.

NOTICE

To avoid damage to the instrument and leakage from the batteries, please remove the batteries if the instrument is unlikely to be used for some time.

NOTICE

It is important that instructions set forth in this manual are followed closely in order to maintain the safety and full functionality of the instrument.

NOTICE

External power supply through USB socket.



Within the European Union it is illegal to dispose electric and electronic waste as unsorted municipal waste. Electric and electronic waste may contain hazardous substances and therefore has to be collected separately. Such products will be marked with the crossed-out wheeled bin shown below. The cooperation of the user is important in order to ensure a high level of reuse and recycling of electric and electronic waste. Failing to recycle such waste products in an appropriate way may endanger the environment and consequently the health of human beings. Disposal of batteries must be made according to national regulations.

Warranty

INTERACOUSTICS warrants that:

- The AS608/AS608e is free from defects in material and workmanship under normal use and service for a period of 24 months from the date of delivery by Interacoustics to the first purchaser.
- Accessories are free from defects in material and workmanship under normal use and service for a period of ninety (90) days from the date of delivery by Interacoustics to the first purchaser.

If any product requires service during the applicable warranty period, the purchaser should communicate directly with the local Interacoustics service centre to determine the appropriate repair facility. Repair or replacement will be carried out at Interacoustics' expense, subject to the terms of this warranty. The product requiring service should be returned promptly, properly packed, and postage prepaid. Loss or damage in return shipment to Interacoustics shall be at purchaser's risk.

In no event shall Interacoustics be liable for any incidental, indirect or consequential damages in connection with the purchase or use of any Interacoustics product.

This shall apply solely to the original purchaser. This warranty shall not apply to any subsequent owner or holder of the product. Furthermore, this warranty shall not apply to, and Interacoustics shall not be responsible for, any loss arising in connection with the purchase or use of any Interacoustics product that has been:

- repaired by anyone other than an authorized Interacoustics service representative;
 - altered in any way so as, in Interacoustics judgement, to affect its stability or reliability;
 - subject to misuse or negligence or accident, or which has had the serial or lot number altered, effaced or removed;
- or

- improperly maintained or used in any manner other than in accordance with the instructions furnished by Interacoustics.

This warranty is in lieu of all other warranties, express or implied, and of all other obligations or liabilities of Interacoustics, and Interacoustics does not give or grant, directly or indirectly, the authority to any representative or other person to assume on behalf of Interacoustics any other liability in connection with the sale of Interacoustics products.

INTERACOUSTICS DISCLAIMS ALL OTHER WARRANTIES, EXPRESSED OR IMPLIED, INCLUDING ANY WARRANTY OF MERCHANTABILITY OR FOR FUNCTION OF FITNESS FOR A PARTICULAR PURPOSE OR APPLICATION

Air Conduction

Hearing threshold levels can be determined by presenting test signals to the test subject with the included earphones (air conduction – AC). The purpose of AC audiometry is to establish the hearing sensitivity at various frequencies. The test can specify the AC loss but cannot distinguish between abnormality in the conductive mechanism and sensor neural mechanism.

Headset Placement:

Remove eye glasses and ear rings if possible and position the headband directly over the top of the head. Place the rubber cushions so that the diaphragms are aimed directly at the opening into the ear canal. Pull down the yokes of the phones and adjust for tight fit. If the cushions are not tight to the ears, the test results may be false at lower frequencies.

Background Noise:

Background noise can also produce false test results, especially at lower frequencies. If necessary, the DD45 can be equipped with noise excluding enclosures. Please contact the distributor for more information.

Instruction of Subject:

Prior to hearing threshold level measurements, the following instructions should be given. "You will now hear a variety of pitches with various loudness levels. Please push the signal button when you hear a tone and release the button when you no longer hear it. If not using the response button, ask the patient to "raise their left or right hand when you hear the tone in the left or right ear".

Threshold Determination:

The test normally starts at 1000 Hz on the patient's better ear with the L/R switch adjusted accordingly.

Familiarization:

Present a tone at 1000 Hz which can easily be perceived (i.e. 50dB) If necessary, increase with steps of 10 dB until the tone is clearly perceived.

Threshold Determination:

The hearing threshold is defined as the lowest level at which more than half of the stimuli are heard. This threshold is found by the following procedure.

- 1) Present a tone which is 10 dB lower than the level at which familiarization was finished.
- 2) Decrease the level in steps of 10 dB until response fails.
- 3) Increase the level in steps of 5 dB until the subject responds again.
- 4) Repeat 2) and 3) two or three times until the threshold appears at the same level.

The time intervals in between the stimuli should be varied to prevent the subject to react on the rhythm.

- 5) Change to the next frequency and repeat the procedure until all frequencies are measured. Repeat the procedure at 1000 Hz. If the difference to the previously found threshold is then 5dB or less go to the other ear. If the difference is 10 dB or higher, repeat the test at the other frequencies, until agreement to 5 dB or less has been obtained.
- 6) Proceed until both ears have been tested.

Screening Procedure:

It is common to test at one dB level for preliminary hearing screenings as is often done in schools and primary practice clinics. In this instance you would follow the same familiarization and instruction procedures as stated above, but present a single dB level (i.e. 25dB) at just 4 frequencies (500, 1000, 2000 & 4000 Hz) in each ear. In this instance, you simply record a response or no response to the single tone presentations at each frequency.

Auto Threshold:

In addition to traditional manual testing, the AS608e incorporates a Hughson Westlake patient controlled automatic threshold test complying with ISO 8253. When the test is completed the results are easily recalled from the internal memory of the AS608e and transferred to the Diagnostic Suite PC software and stored in OtoAccess™ or Noah.

Hughson Westlake is an automatic pure tone test procedure. Threshold is defined as 2 out of 3 (or 3 out of 5) correct responses at a certain level in a 5 dB increase and 10 dB decrease test procedure. The Hughson Westlake is used to obtain pure tone thresholds automatically.

Talk Forward

The Talk Forward function makes the AS608e easy to work with particularly in sound booth installations.

Functions of Buttons & Display

The AS608/AS608e front plate:

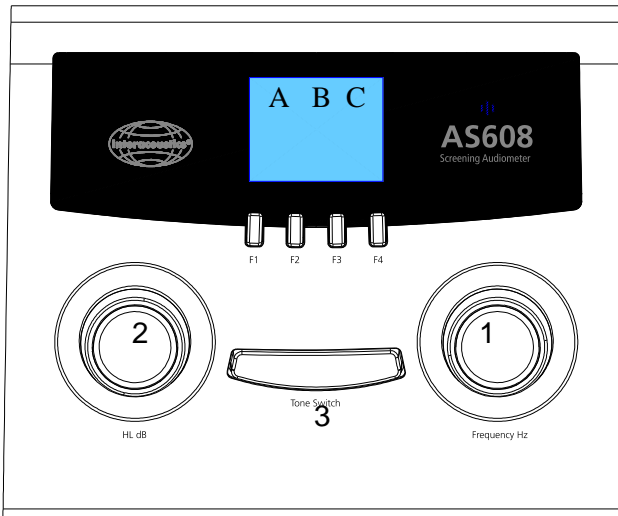

Power Up and Power Off:

To turn on the audiometer press the Tone Switch (3) button. To power off the audiometer hold down the two rotary wheel buttons, 1) and 2), simultaneously for a few seconds. The audiometer will also automatically power off after 1, 2, 3, 4 or 5 minutes depending on the settings (see next section).

Pure Tone Presentation

- 1) Select desired frequency with the "Frequency" button
- 2) Select desired intensity with the HL dB.
- 3) Present tone by touching Tone Switch. An indication will be on Display (see below).

F1) On AS608: Select the Right ear. On AS608e: Toggle between Right and Left.

F2) On AS608: Select the Left ear. On AS608e: Store threshold.

F3) Manual or Pulse:

Manual: Manual Tone presentation as long as the Tone Switch is activated.

Pulse: Pulsing Tone will be presented as long as the Tone Switch is activated.

F4) Pure Tone or Warble:

If Tone is selected pure tones will be presented to the subject when the Tone Switch is activated.

If Warble is selected warble tones will be presented to the subject when the Tone Switch is activated.

AS608e Special Functions:

Talk Forward: On the AS608e Talk Forward is activated by holding down the HL db (3) rotary wheel.



While holding down the The Talk button (3), the talk forward level can be adjusted.

The following F-key functionalities can be access by pressing the frequency rotary wheel (1):

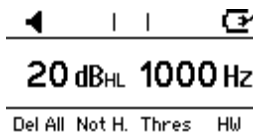

F1: Delete all thresholds stored in the internal memory of the AS608e.

F2: Store a Not Heard threshold point.

F3: Display the L/R thresholds stored in the internal memory of the AS608e.

	Thresholds				
Hz	125	250	500	750	
R	20	20	20	20	
L	20	20	20	20	
Del All		←	→	Back	

F4: Start the Hughson Westlake (HW) automatic test procedure. Please refer to the next chapter for instructions about how to setup the HW test.

Display:

- A) **Tone:** A tone presentation indicator is provided in the top left corner of the display header.

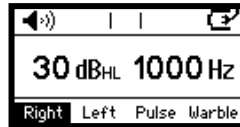
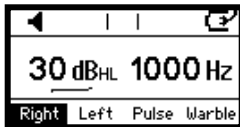

- B) **Response:** When using the APS3 response button, a response is indicated in the middle of display header.

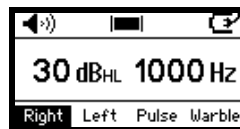
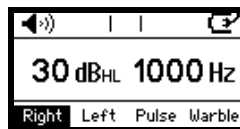

- C) **Power On or Battery status:** The power status of the AS608/AS608e is indicated in the top right corner of the display header.

The icon will change depending on whether the instrument is powered via an external source (power supply or USB connection to computer) or batteries.

When powered by batteries, the battery icon will change depending on the battery power level. When batteries are running low the display will read Low Battery and flash.

The Power Off settings of the instrument can be adjusted at different time intervals or set to never power off – please see Setup section for details.

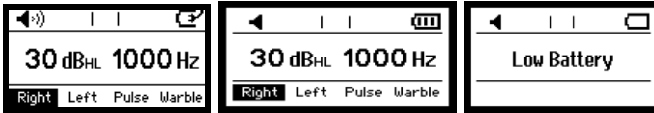

Setup Menu of AS608/AS608e

To access the AS608/AS608e setup menu press F1 and F4 simultaneously for 2-3 seconds.

F1	Change setting
F2	Browse up in the setup menu
F3	Browse down in the setup menu
F4	Save settings and Back to previous screen display – see below for details

Power up Tone

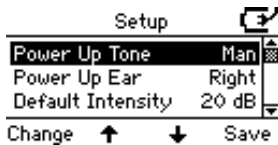

Press Change to toggle between Manual and Reverse.

Power up Ear

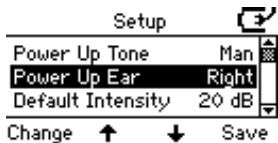

Press Change to toggle between Right and Left ear as the default ear for Power Up

Default Intensity

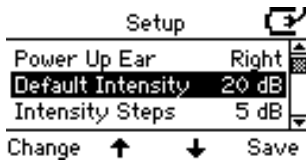

The default intensity when changing ear side. Choose between: Off, -10dB, -5dB, 0dB, 5dB, 10dB, 15dB, 20dB, 25dB, 30dB, 35dB, 40dB, 45dB and 50dB.

Intensity Steps

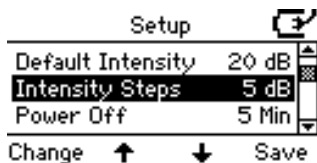

Choose Between: 1 dB and 5 dB.

Power Off setting

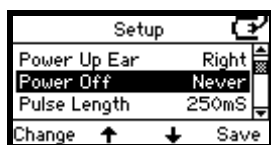

Press Change to toggle between Never, 1, 2, 3, 4 or 5 minutes.

Pulse Length

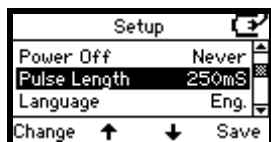

Press Change to toggle between 250msec and 500msec.

Language

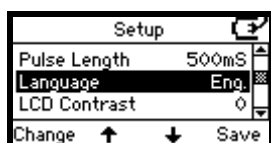

Press Change to toggle between English, German, Spanish and French.

LCD Contrast.

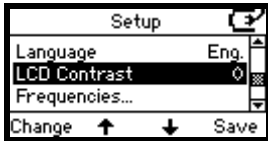

Press Change to toggle between settings ranging from 0 (very bright) to 6 (very dark).

HW Test... (only on AS608e)

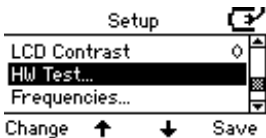

Press Change to go to the Hughson Westlake (HW) automatic test procedure setup.

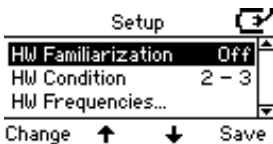

Press Change to toggle between Familiarization On/Off. Familiarization is used to train the patient

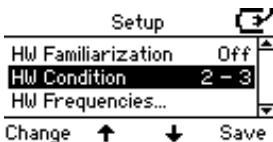

Press Change to toggle between “2 correct out of 3 answers” and “3 correct out of 5 answers”. The conditions used before going to the next frequency.

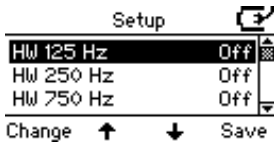

Select the frequencies to include in the HW test. Press Change to toggle between frequencies On/Off.

Press Save to return to the main HW setup menu.

Frequencies



Press Change to access the default frequency range from 125Hz to 8 kHz for daily operation.

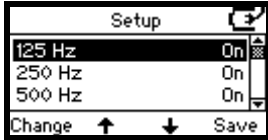

7 frequencies are available to change: 125, 250, 750, 1,500, 3,000, 6,000 and 8,000.

Press Change to toggle between On or Off.
Press Save to return to the main setup menu.

License.



Press Change to access the license key of the AS608/AS608e instrument.



Press Change to enter and/or modify the license key of the AS608/AS608e instrument.

Use button 2 to change the letter and button 1 to move the cursor

Press Save to return to the main setup menu.

About

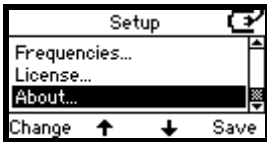

Press Change to access the information in the About section.



Press Back to return to the main setup menu.

Press Save to return to measurement screen of the AS608/AS608e.

Technical Specifications

Standards:

Meets or exceeds EN 60645-1 type 4 and ANSI S3.6
Safety Standard: EN 60601-1, Class II, type B.
EMC: EN 60601-1-2

Calibration:

ISO 389-1 (DD45)
ISO 389-2 (EAR-Tone 3A and 5A)
PTB Report 1.61-64/04 (HDA280).
PTB Report 1.61-4039503/09 (DD45)

Medical CE-mark:



The CE-mark indicates that Interacoustics A/S meets the requirements of Annex II of the Medical Device Directive 93/42/EEC. TÜV Product Service, Identification No. 0123, has approved the quality system.

Frequencies and Intensities:

Freq. Hz.	AC, dB HL
125	70
250	90
500	100
750	100
1000	100
1500	100
2000	100
3000	100
4000	100
6000	100
8000	90

Inputs: Tone

Warble Tone $\pm 5\%$, 5Hz (true sine wave frequency modulation).

Outputs: Left and Right.

Tone Presentation:

Manual or Reverse (chosen in Setup Menu).
Multiple pulses 250 or 500msec (chosen in Setup Menu.).

Talk Forward:

Built in talk forward microphone. 0-110dB SPL. Continuously adjustable on operation panel.

Auto Threshold:

Patient controlled Hughson Westlake procedure according to ISO 8253-1.

Store Function:

Soft key (F-key) store button and internal memory for AC L/R. Stored Measurements can be viewed on the built in display or transferred to the PC using the Diagnostic Suite Audiogram software module.

PC Software / Interface: The Diagnostic Suite PC software with advanced reporting and printing features. OtoAccess™ and Noah compatible.

Distortion:

0,3% typical at full intensity.
1% maximum at full intensity.

Rise/fall Times:

35 msec. typically.

Display Header Indicators:

Tone On.
Patient Response.
Power/Battery Status

Batteries:

3 AA size.
Automatic battery on/off switching.
Automatic battery status indication.

Battery life:

Standby: 6 months
Tone presentations: 70.000

External Power Supply (though USB connector):

Accepts 5 VDC – minimum 150 mA.
The recommended ASA30M-0301 (100-240 VAC, 0.8 – 0.4 Amp) is approved with the AS608/AS608e.

Construction:

Plastic cabinet.

Dimensions:

WxDxH: 22.5 x 18 x 5.5 cm / 8,9 x 7.1 x 2,2 inches

Weight: 1.0 kg – including batteries and headset.
1.6 kg – including TC608 carrying bag incl. peltor noise reducing headset, audiogram charts etc.

Operating Environment:

Temperature: 15-35°C/59-95°F.
Relative Humidity: 30-90 %.

Storage Environment:

Temperature: 0-50°C/32-122°F.
Relative Humidity: 10-95 %.

Transport Environment:

Temperature: -20-50°C/-4-122°F.
Relative Humidity: 10-95 %.

Computer requirements:

Must comply with IEC 60950-1.
Equipped with a USB connection.

Parts

Included Parts:

- DD45 Audiometric Headset
- 200 AF12 Audiogram Charts
- TC608 Carrying Bag
- Pen set, 3 pens
- Operation Manual
- Multilingual CE operation instructions
- CD Diagnostic Suite (only AS608e)

Additional Parts:

- ASA30M-0301 External Power Supply Medical CE Approved
- APS3 Patient Signal Button
- 21925 Audiocup Noise Excluders
- 50250 Peltor Noise Excluders

Electrical Installation

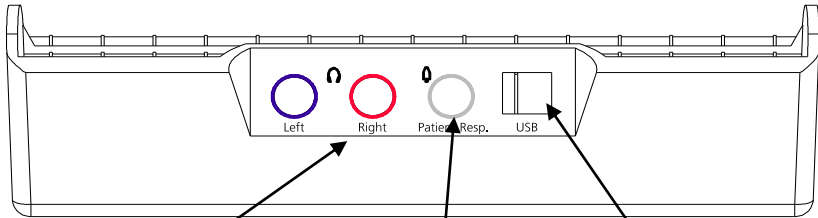

Sockets for transducers
(left = blue and right = red)

Socket for
patient response
(APS3)

Socket for
external power
supply

Compartment for three
AA-size batteries

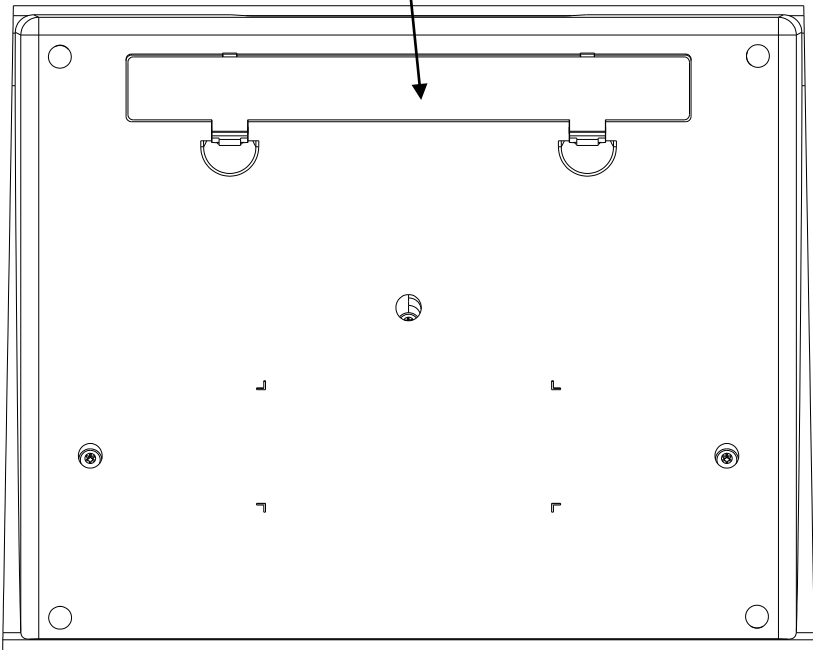

External Connections - Standard Accessories

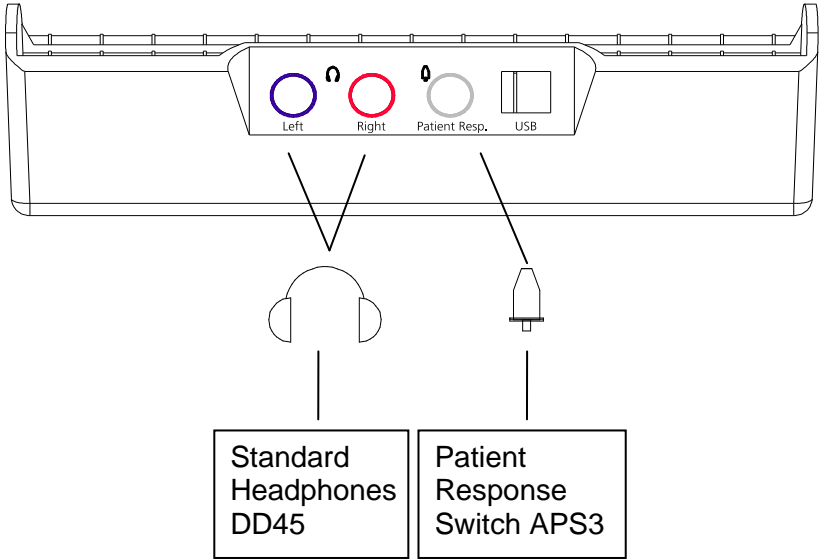

Unpacking / Inspection

Check box and contents for damage:

When the instrument is received, please check the shipping box for rough handling and damage. If the box is damaged, it should be kept until the contents of the shipment have been checked mechanically and electrically. If the instrument is faulty, please contact the nearest service office. Keep the shipping material for the carrier's inspection and insurance claim.

Keep carton for future shipment:

The AS608/AS608e comes in its own shipping carton, which is specially designed for the AS608/AS608e. Please keep this carton. It will be needed if the instrument has to be returned for service. If service is required please contact your nearest sales and service office.

Contents of Shipment

Delivered items with AS608/AS608e:

AS608/AS608e is as a standard unit delivered with the following:

Quantity	Item	Order No.
1	Instrument	AS608/AS608e
1	Audiometric Headset	DD45
200	Audiogram Forms	AF12
1	Pen Set, 3 pens	
1	Carrying bag	TC608
1	Operation manual	
1	Multilingual CE operation instructions	
1	CD Diagnostic Suite (only AS608e)	

Check numbers on AS608/AS608e and Manual:

The identification label on the rear plate holds the serial number. This should be checked with the manual number and written down for later service claims.

To observe the CE-mark of AS608/AS608e with an external power supply, the power supply must be CE-medical approved.

When AS608/AS608e is supplied with the external power supply model EPS11 write down the serial number located on its bottom plate.

<h2>Reporting Imperfections</h2>

Inspect before connection:

Prior to connecting the AS608/AS608e to the mains it should once more be inspected for damage. All of the cabinet and the accessories should be checked visually for scratches and missing parts.

Report immediately any faults:

Any missing part or malfunction should be reported immediately to the supplier of the instrument together with the invoice, serial number, and a detailed report of problem. In the back of this manual you will find a "Return Report" where you can describe the problem.

Please use "Return Report":

Please realise that if the service technician does not know what problem to look for he may not find it, so using the Return Report will be of great help to us and is your best guarantee that the correction of the problem will be to your satisfaction.

Operating Temperature

Keep away from heat:

Do not site the AS608/AS608e next to a radiator or any other heat source. Allow six inches between the back panel and the wall to ensure proper ventilation.

Operating temperature: 15C°- 35C°/ 59°-95°F:

In operation the instrument should not be subject to temperatures below 15C° or above 35C°/ below 59°F or above 95°F.

If it has been exposed to abnormal low temperatures the warm-up time must be respectively prolonged.

Care and Maintenance

The performance and reliability of the AS608/AS608e will be prolonged if the following recommendations for care and maintenance are adhered to:

Using an external power Supply e.g. ASA30M-0301 - Turn the switch to the off position.

Great care when handling the headset:

Great care should be exercised when handling the headset as dropping it may alter the calibration.

Annual calibration headset:

The AS608/AS608e has been designed to provide many years of reliable service, but annual calibration is recommended.

We do also recommend to calibrate the AS608/AS608e if something drastic happens to part of it (e.g. headset is dropped).

Trouble Shooting

AS608/AS608e does not turn on:

Using External Power Supply:

The power cable must be correctly connected to the mains.

The mains switch must be "on", and the power switch on the external power supply must also be "on".

If still nothing happens a fuse in the external power supply may be blown. Replace fuses with exactly the same type.

Using Batteries:

The batteries might need to be changed - an indication on the top right corner of the display will be provided and the operator prompted on the status via a flashing screen.

External Power Cable connected to AS608/AS608e will disconnect batteries - unplug cable for battery operation.

No tones in the DD45 headphone:

Left (F1) or Right (F2) ear must be selected.

The Attenuator (2) must be turned up.

The "Tone" presentation signal (A) must be activated by touching the Tone Switch.

If still no sound appears check that the headphone is correctly connected to the "phone" outputs.

Dictionary

Position:	Symbol:	Explanation (English):
F1	AS608: Right AS608e: Right/Left	AS608: Selects Right headphone. AS608e: Toggles between right and left headphone.
F2	AS608: Left AS608e: Store	AS608: Selects Left headphone. AS608e: Stored the selected threshold in the internal memory
F3	Man / Pulse	Select Man to have the tone presented when Tone Switch is activated. Select Pulse to present pulsing tones when the Tone Switch is activated.
F4	Pure Tone / Warble	Select Pure tone or Warble tone as stimulus.
1	Frequency	Selects stimulus frequency.
2	HL dB	Adjustment of Intensity
3	Tone Switch	Presents stimulus.
A (Display)	Tone	Indicates presentation.
B (Display)	Response	Indicates response from patient.
C (Display)	Power On / Battery Low	Indication of Power/Battery status.

Appendix:

General Maintenance Procedures

The performance and safety of the instrument will be kept if the following recommendations for care and maintenance are observed:

- It is recommended to let the instrument go through at least one annual overhaul, to ensure that the acoustical, electrical and mechanical properties are correct. This should be made by an authorised workshop in order to guaranty proper service and repair.
- Before the connection to the mains network, be sure that the local mains voltage corresponds to the voltage labelled on the instrument. Always disconnect the power cord if the instrument is opened or by control / replacement of the mains fuses.
- Observe that no damage is present on the insulation of the mains cable or the connectors and that it is not exposed to any kind of mechanical load, which could involve damage.
- For maximum electrical safety, turn off the power from a mains powered instrument when it is left unused.
- Do not site the instrument next to a heat source of any kind, and allow sufficient space around the instrument to ensure proper ventilation.
- To ensure that the reliability of the instrument is kept, it is recommended that the operator at short intervals, for instance once a day, perform a test on a person with known data. This person could be the operator him/herself.
- A plastic cover can be provided to protect the instrument against the accumulation of dust. The cover should only be used when the instrument is left unused with the power turned off.
- If the surface of the instrument or parts of it is contaminated, it can be cleaned using a soft cloth moistened with a mild solution of water and dish washing cleaner or similar. The use of organic solvents and aromatic oils must be avoided. Always disconnect the mains conductor during the cleaning process, and be careful that no fluid is entering the inside of the instrument or the accessories.

- After each examination of a patient, it should be ensured that there is no contamination on the parts in connection with the patient. General precautions must be observed in order to avoid that disease from one patient is conducted to others. If ear cushions or eartips are contaminated, it is strongly recommended to remove them from the transducer before they are cleaned. By frequent cleaning water should be used, but by severe contamination it may be necessary to use a disinfectant. The use of organic solvents and aromatic oils must be avoided.
- Great care should be exercised by the handling of earphones and other transducers, as mechanical shock may cause change of calibration.

Drawing of Front Plate

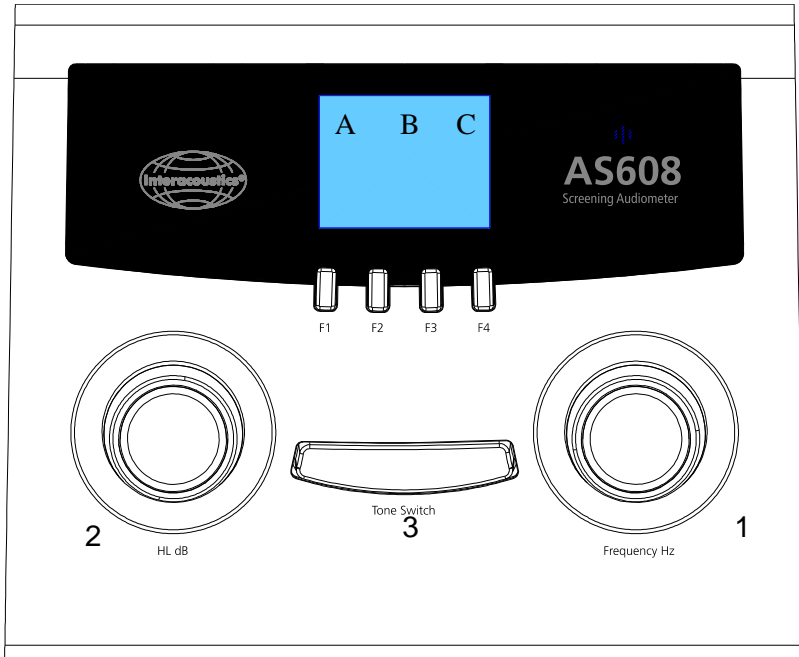

Return Report – Form 001



Opr. dato: 2003-02-24 af: EC Rev. dato: 2006-11-13 af: HNI Rev. nr.: 4

Company: _____

Address: _____

Phone: _____

Fax or e-mail: _____

Contact person: _____ Date : _____

Address
Drejerveanget 8
5610 Assens
Denmark

Phone
(+45) 63713555

Fax
(+45) 63713522

E-mail
info@interacoustics.com

Following item is reported to be:

- returned to INTERACOUSTICS for: repair, exchange, other: _____
- defective as described below with request of assistance
- repaired locally as described below
- showing general problems as described below

Item: Type: _____ Quantity: _____

Serial No.: _____ Supplied by: _____

Included parts: _____

Important! - Accessories used together with the item must be included if returned (e.g. external power supply, headsets, transducers and couplers).

Description of problem or the performed local repair:

Returned according to agreement with: Interacoustics, Other: _____

Date : _____ Person : _____

Please provide e-mail address or fax No. to whom Interacoustics may confirm reception of the returned goods: _____

The above mentioned item is reported to be dangerous to patient or user ¹

In order to ensure instant and effective treatment of returned goods, it is important that this form is filled in and placed together with the item.

Please note that the goods must be carefully packed, preferably in original packing, in order to avoid damage during transport. (Packing material may be ordered from Interacoustics)

¹ EC Medical Device Directive rules require immediate report to be sent, if the device by malfunction deterioration of performance or characteristics and/or by inadequacy in labelling or instructions for use, has caused or could have caused death or serious deterioration of health to patient or user.

